

#632H HORIZONTAL REVEAL

RIGHT SIDE VIEW

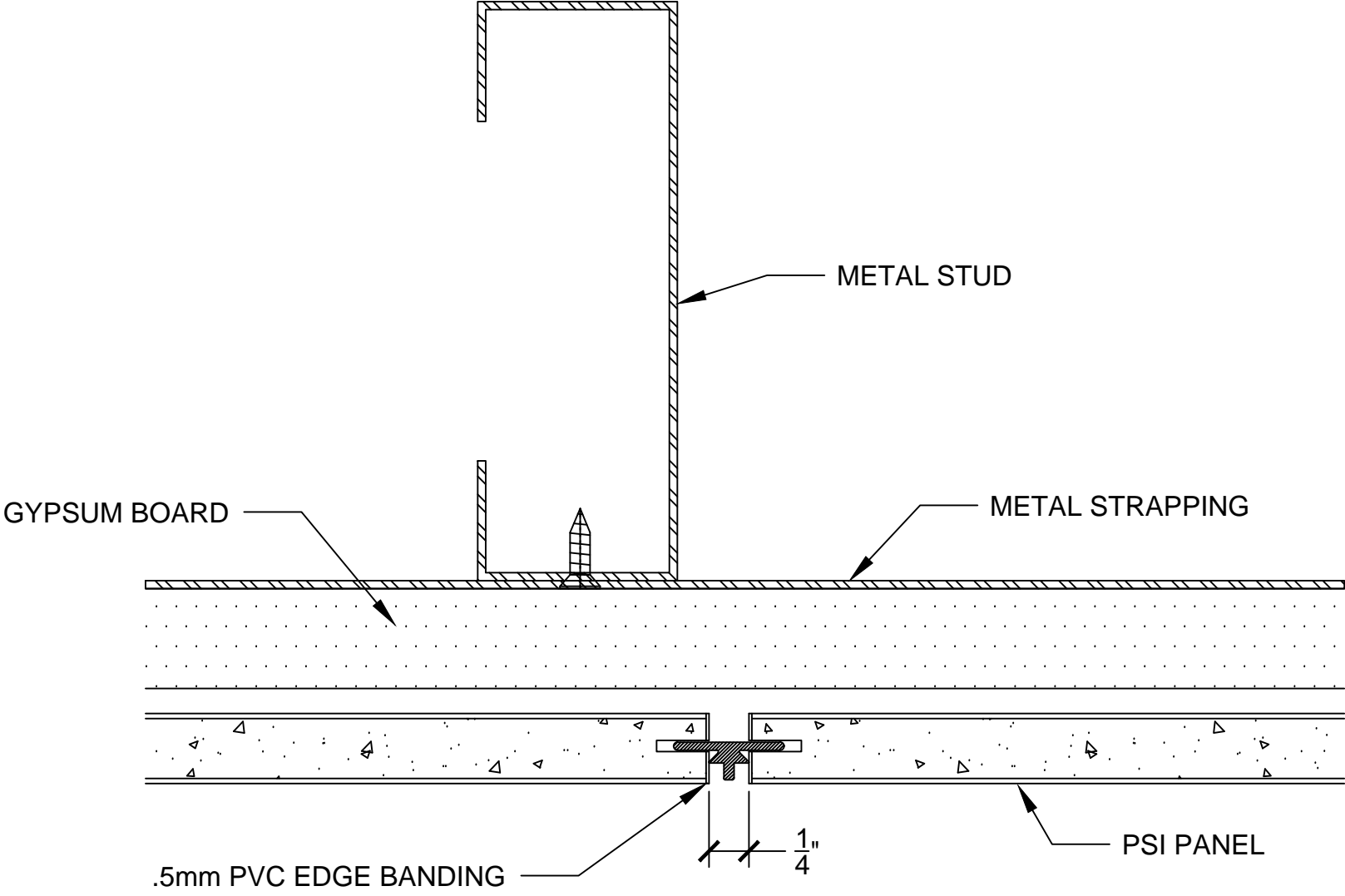

#631V VERTICAL REVEAL

TOP VIEW

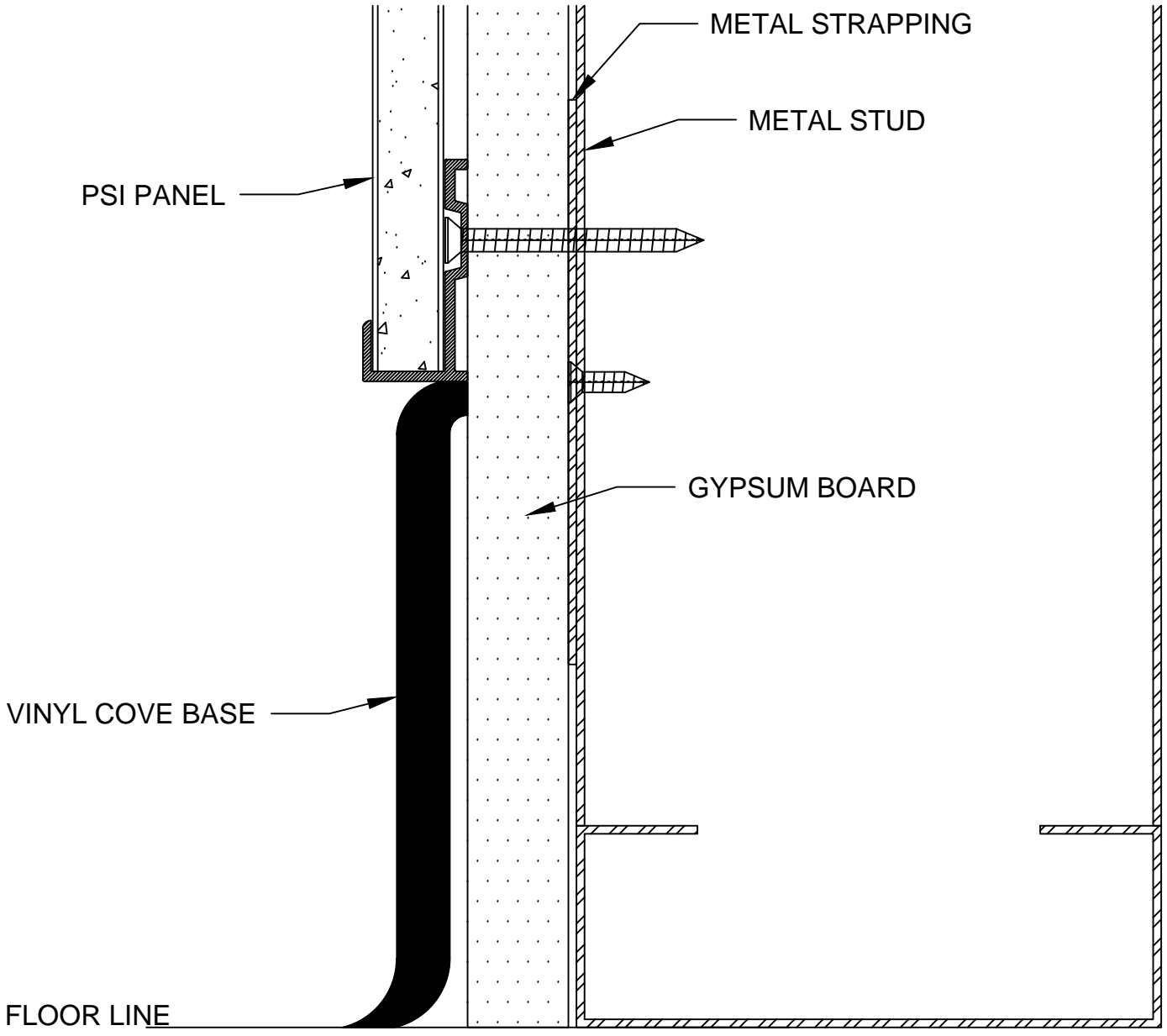

#610 BOTTOM EDGE TRIM - ABOVE BASE

RIGHT SIDE VIEW

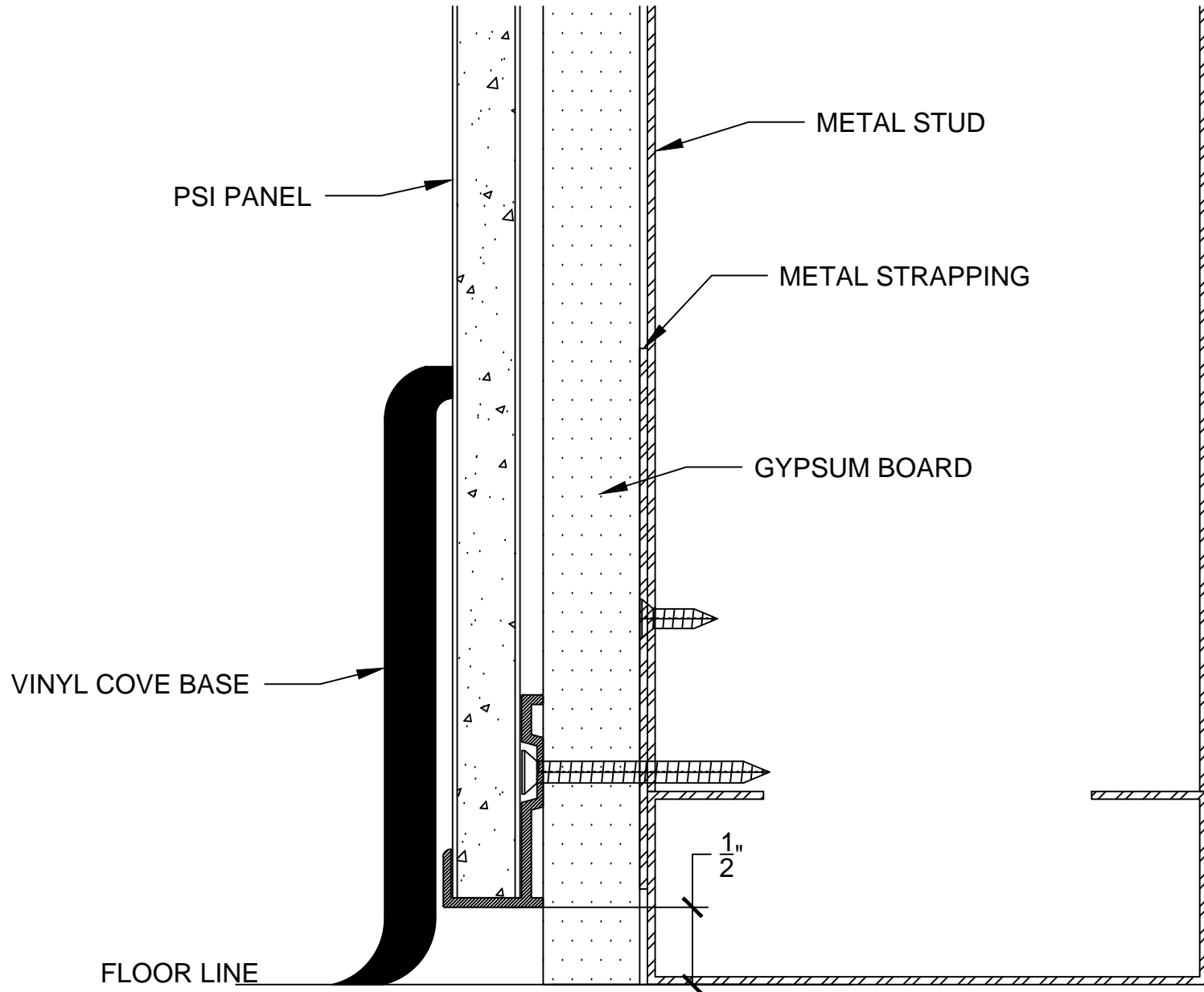

#610 BOTTOM EDGE TRIM - BEHIND BASE

RIGHT SIDE VIEW

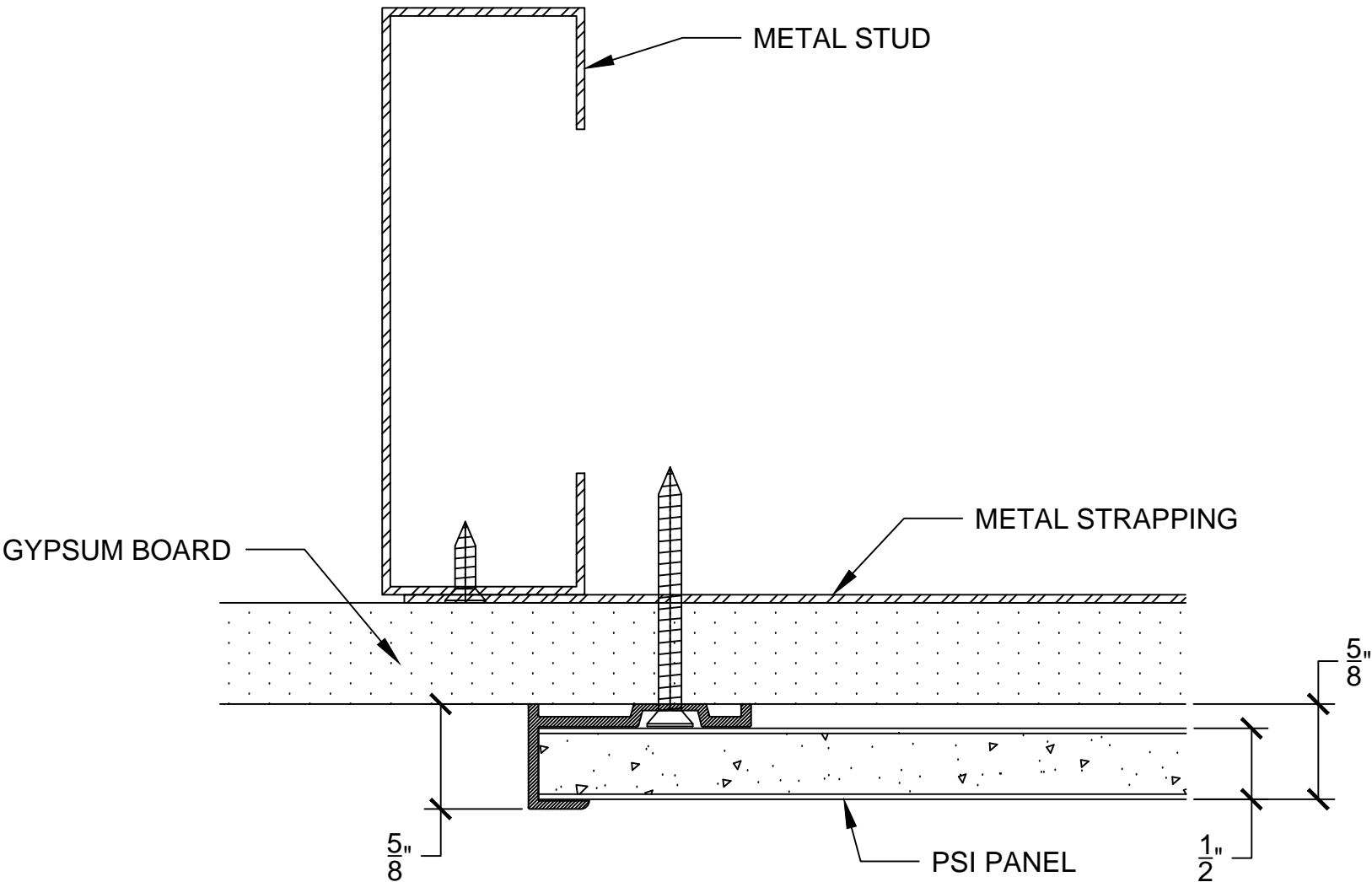

#610 VERTICAL EDGE TRIM

TOP VIEW

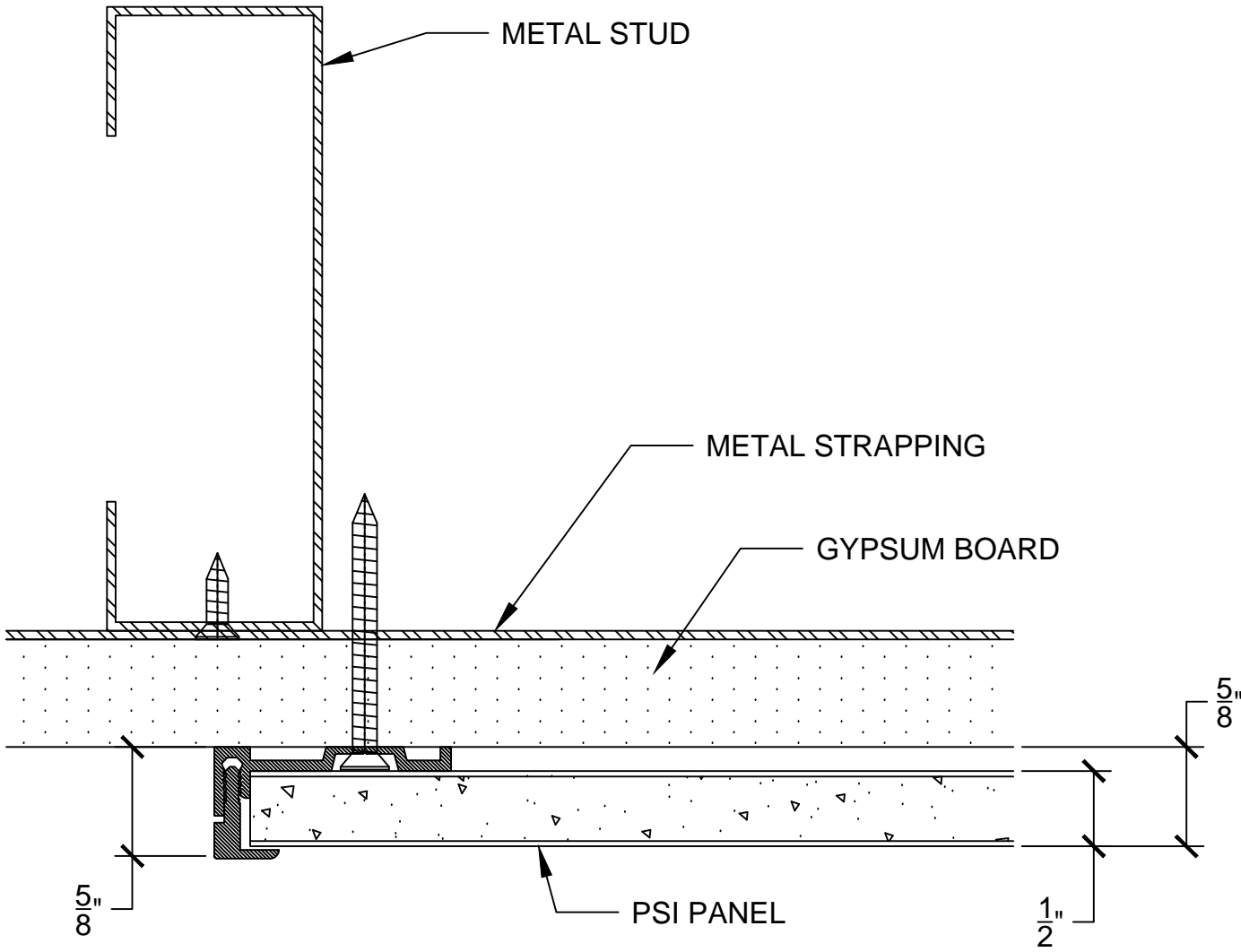

#610A VERTICAL EDGE TRIM

TOP VIEW

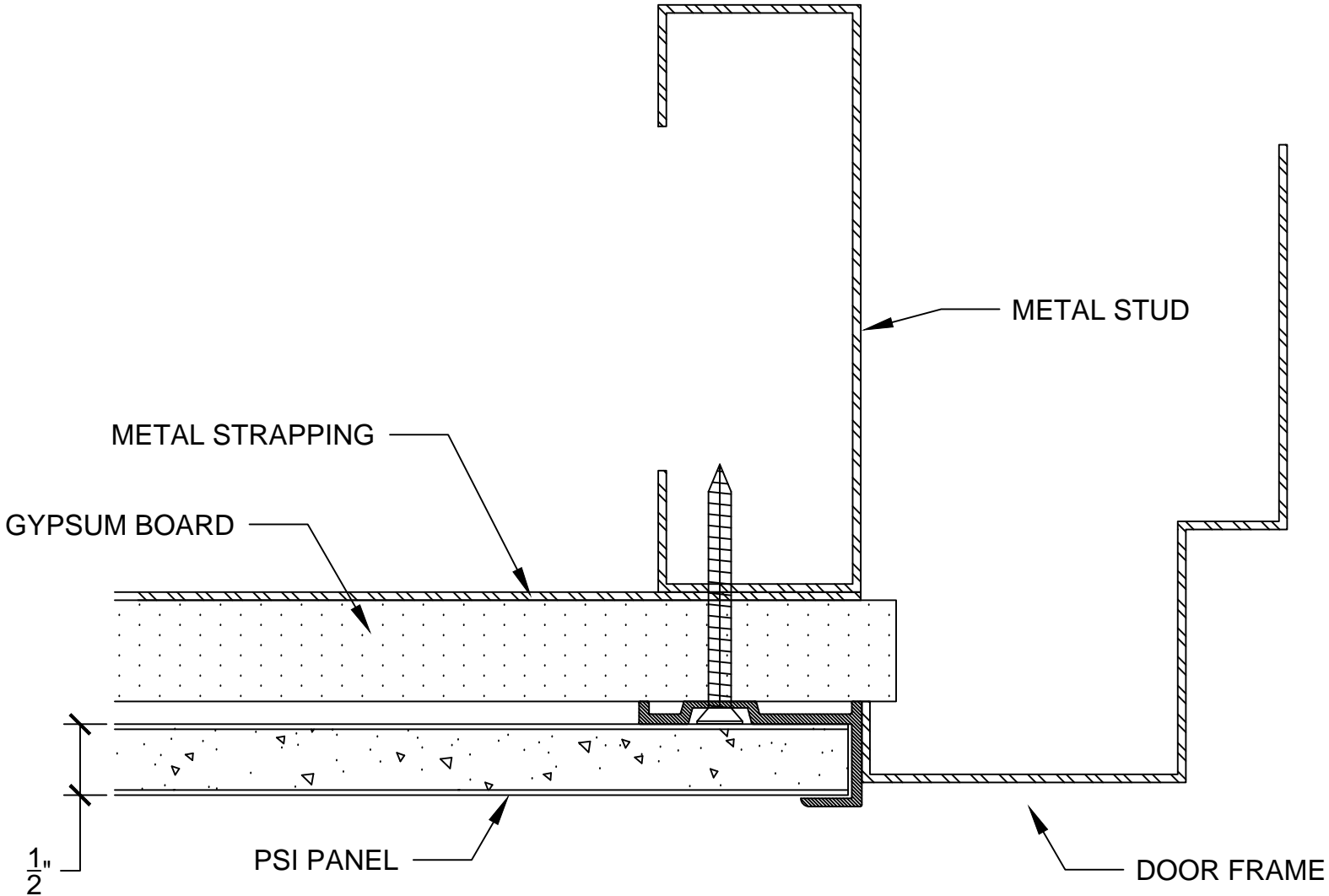

#610 EDGE TRIM @ DOOR OR WINDOW FRAME

TOP VIEW

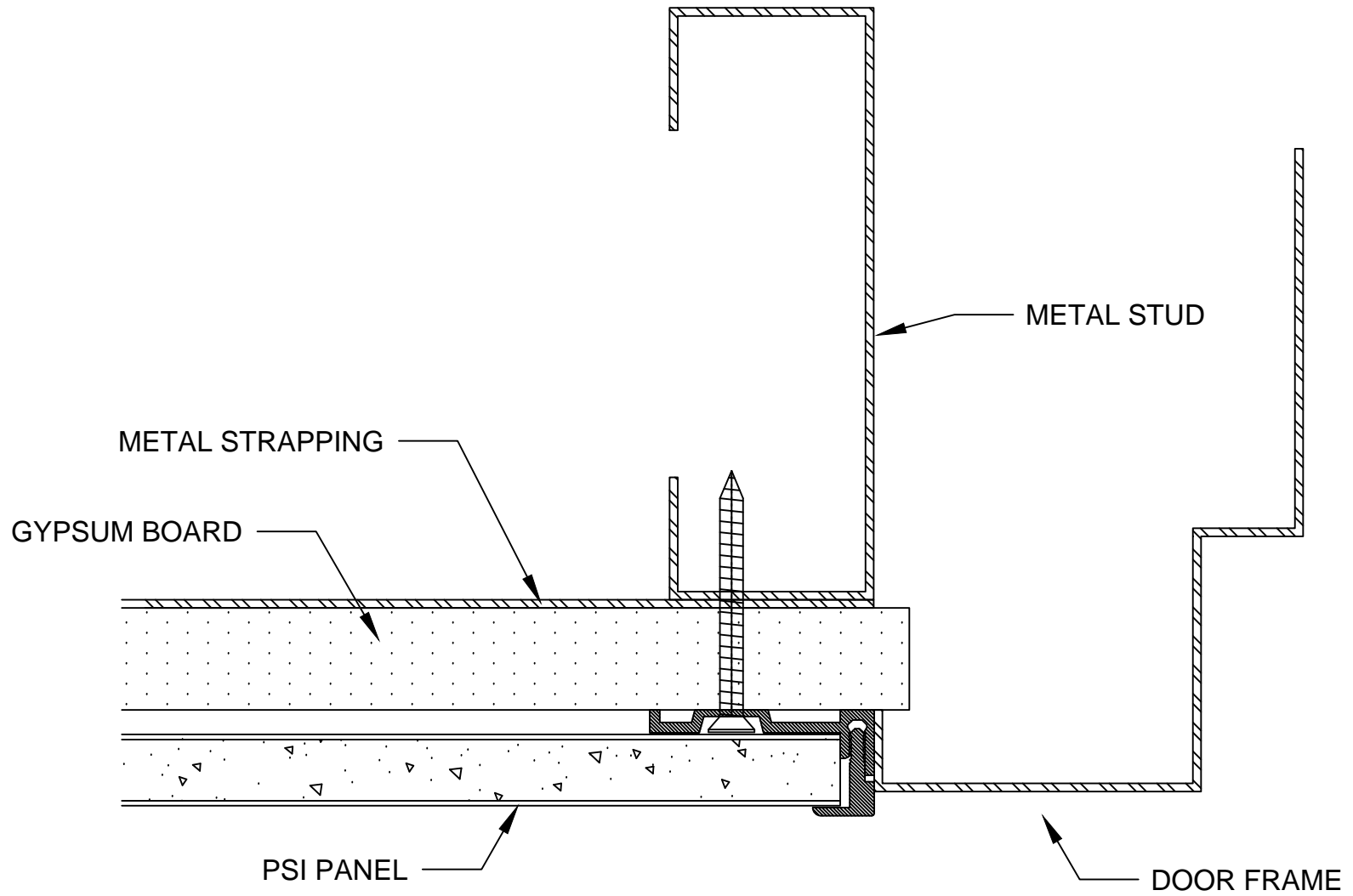

#610A EDGE TRIM @ DOOR OR WINDOW FRAME

TOP VIEW

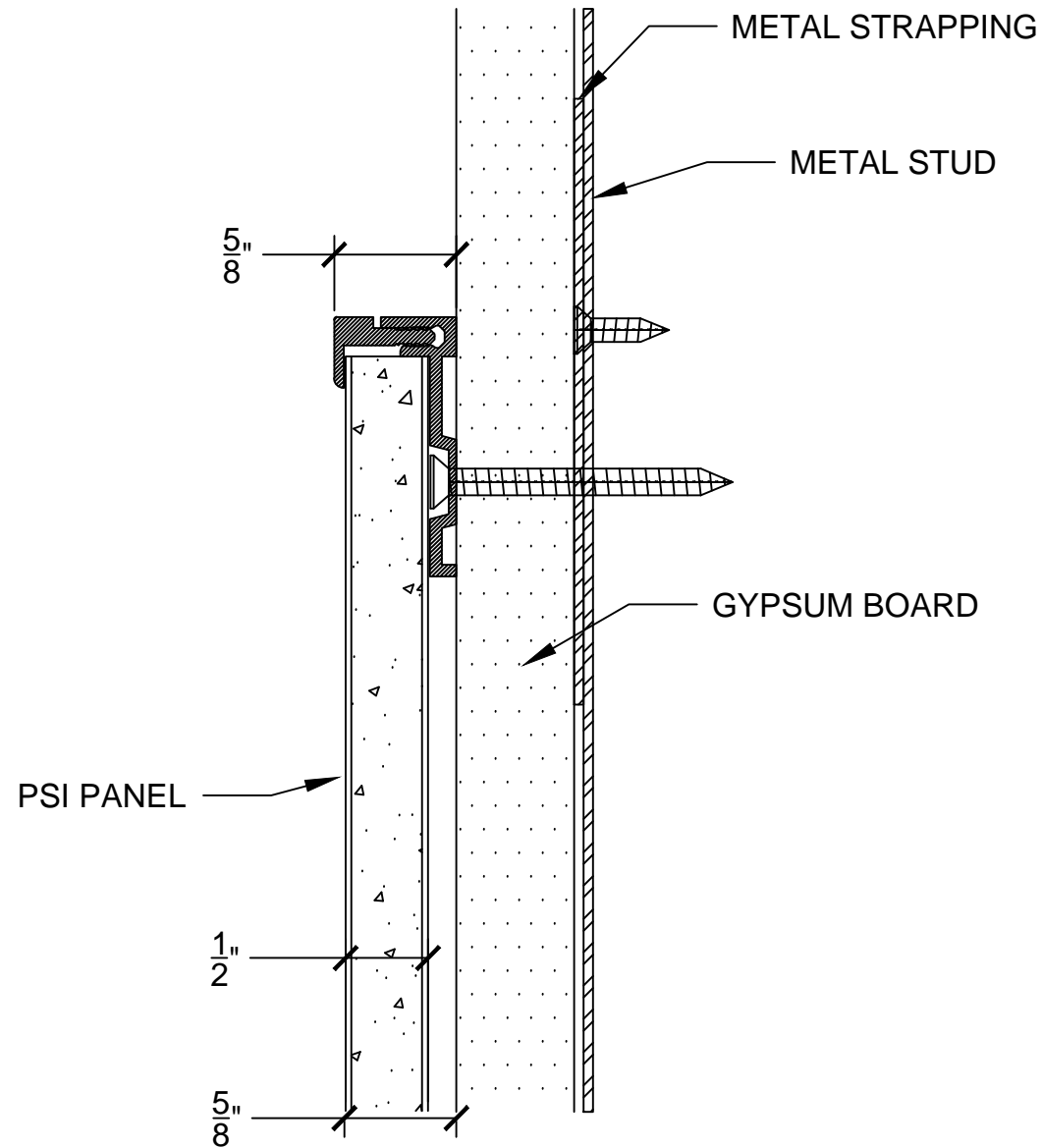

#610A TOP EDGE TRIM

RIGHT SIDE VIEW

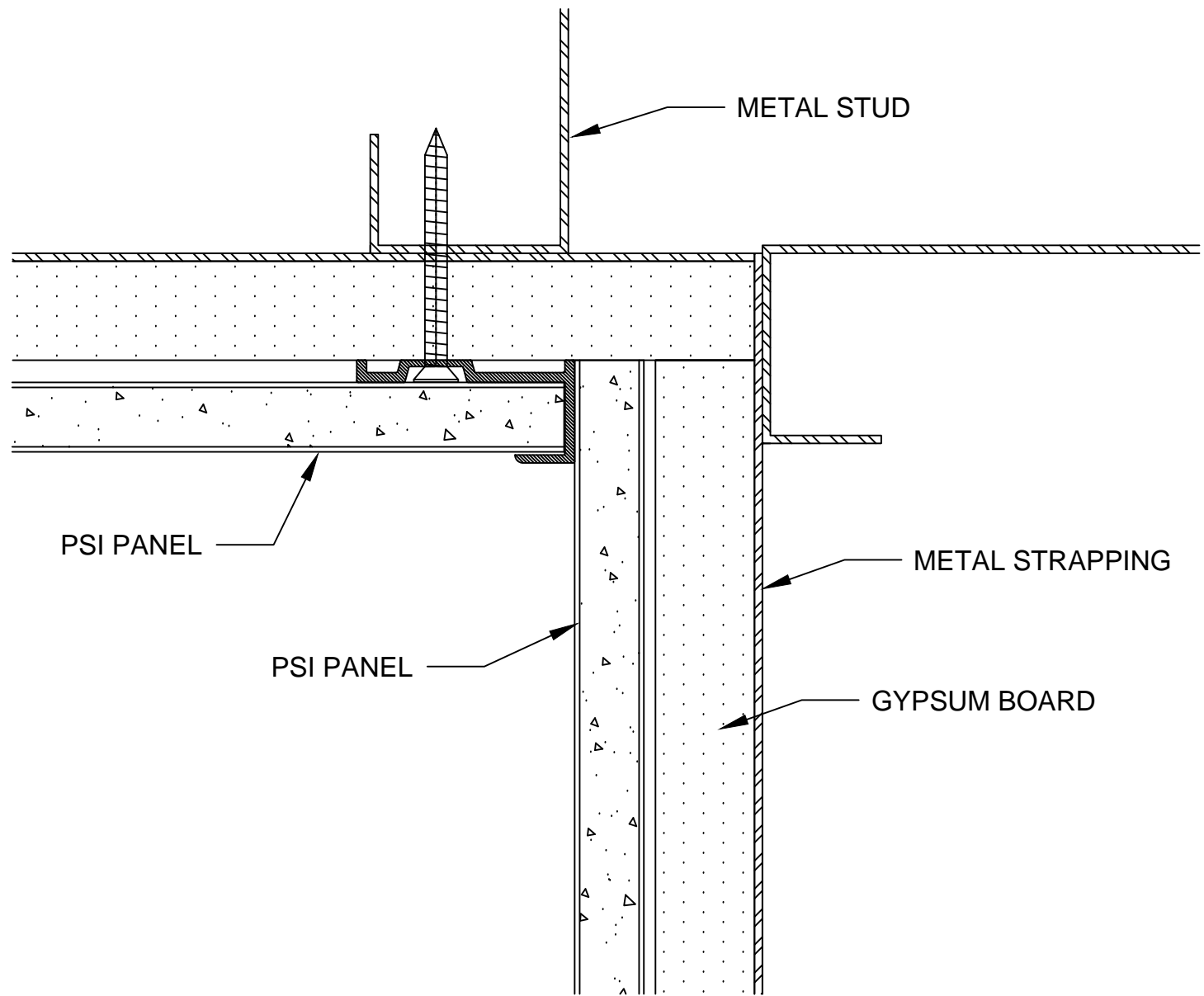

#610 INSIDE CORNER TRIM

TOP VIEW

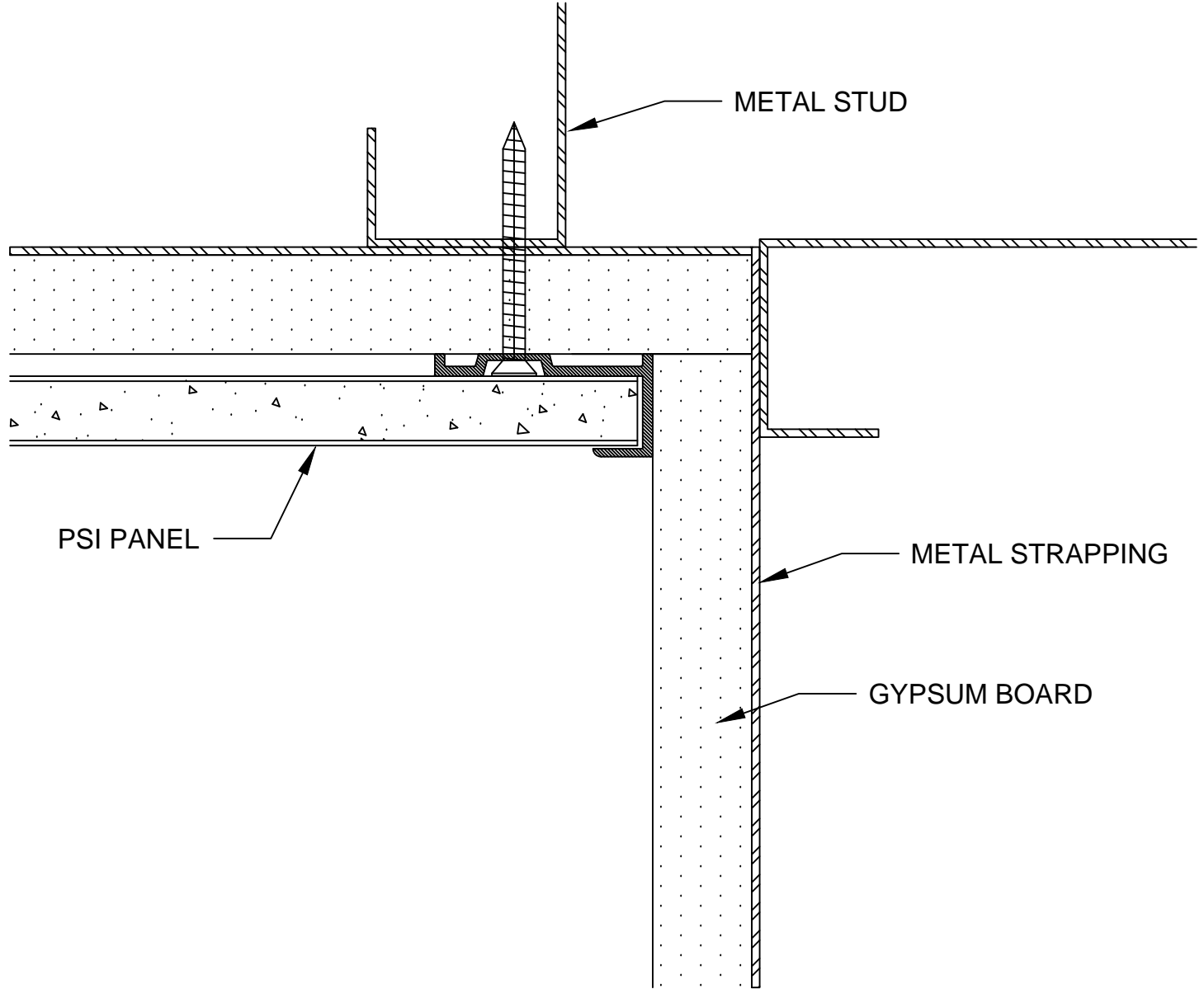

#610 INSIDE CORNER TRIM

TOP VIEW

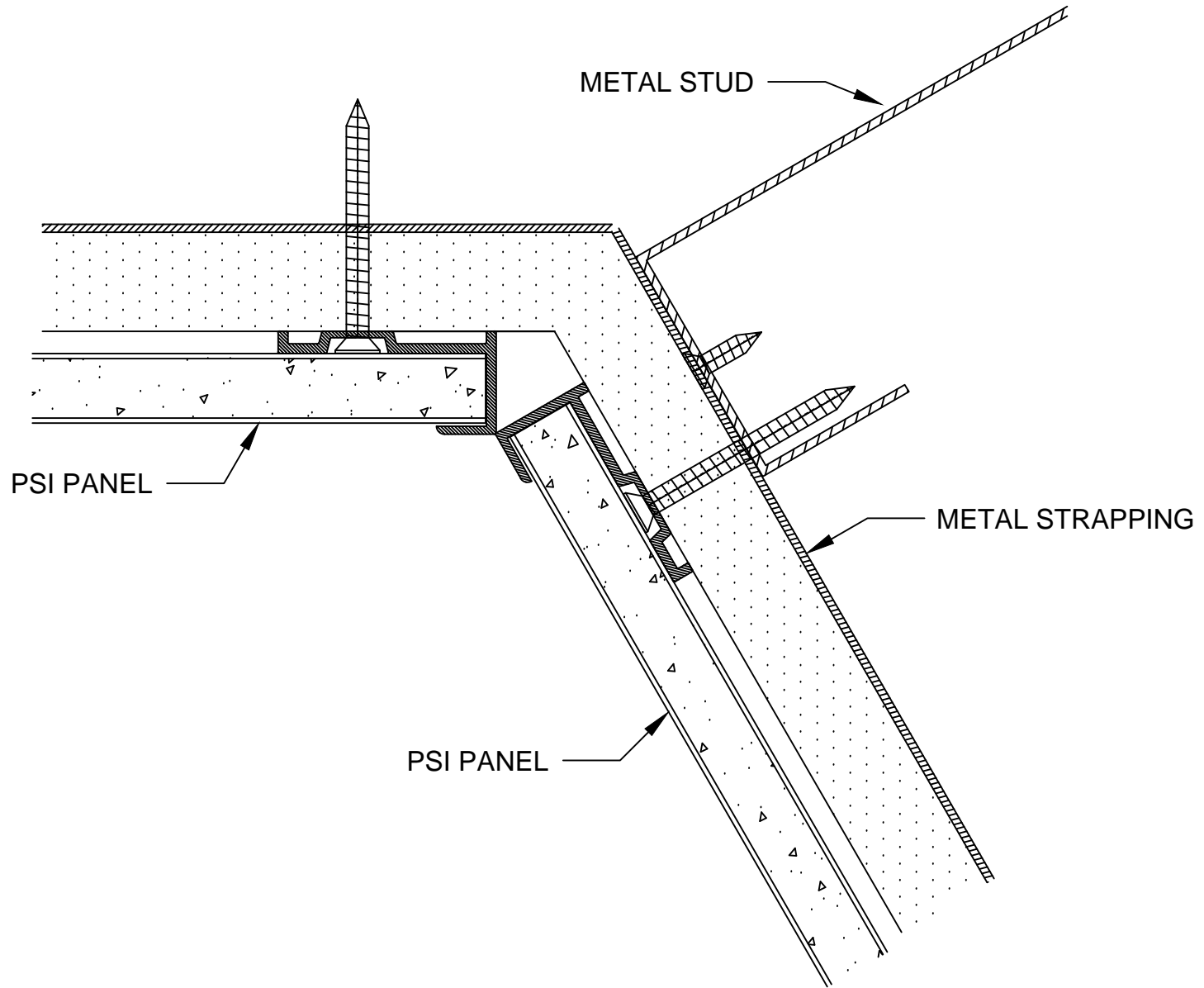

#610 ANGLED INSIDE CORNER TRIM

TOP VIEW

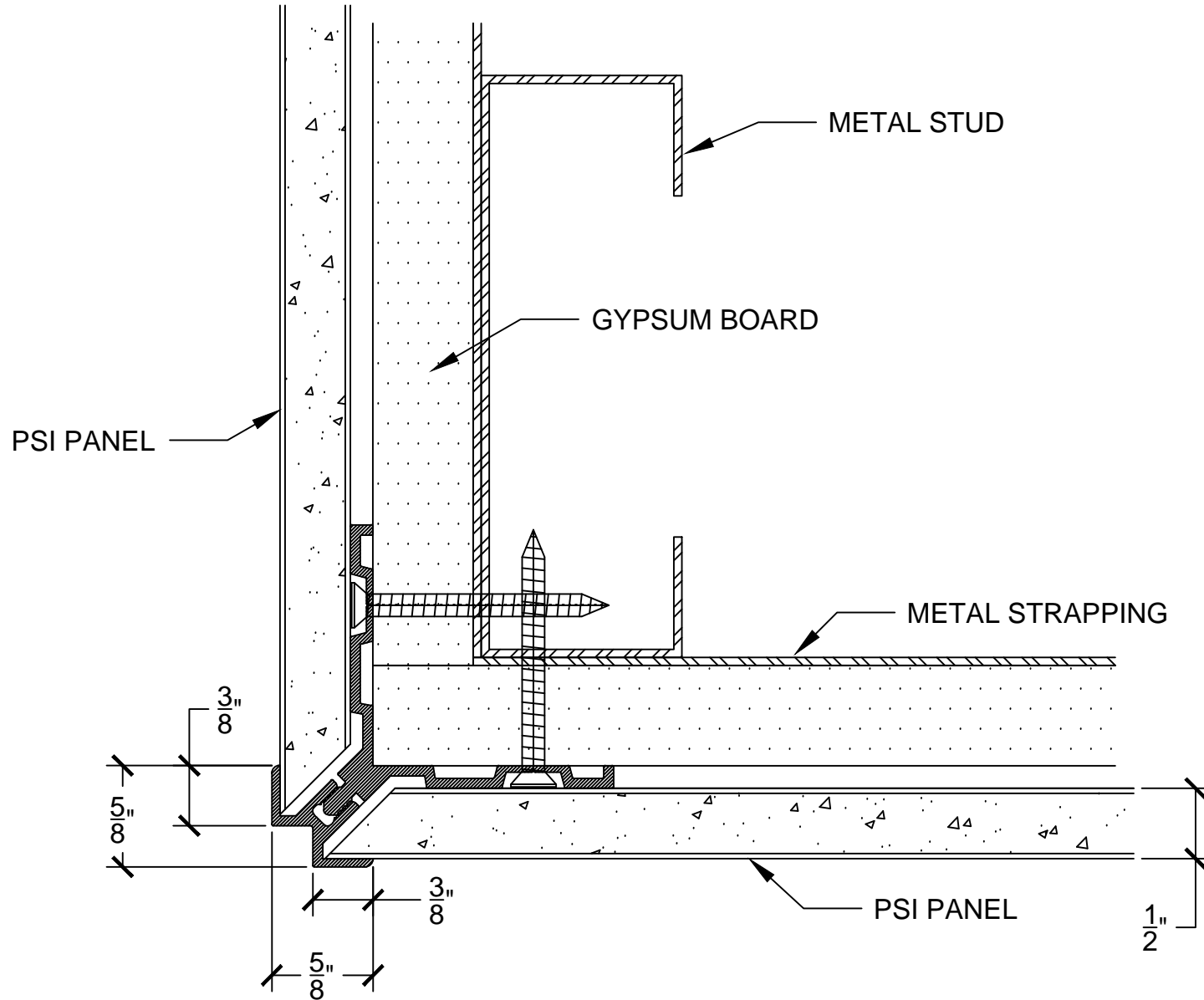

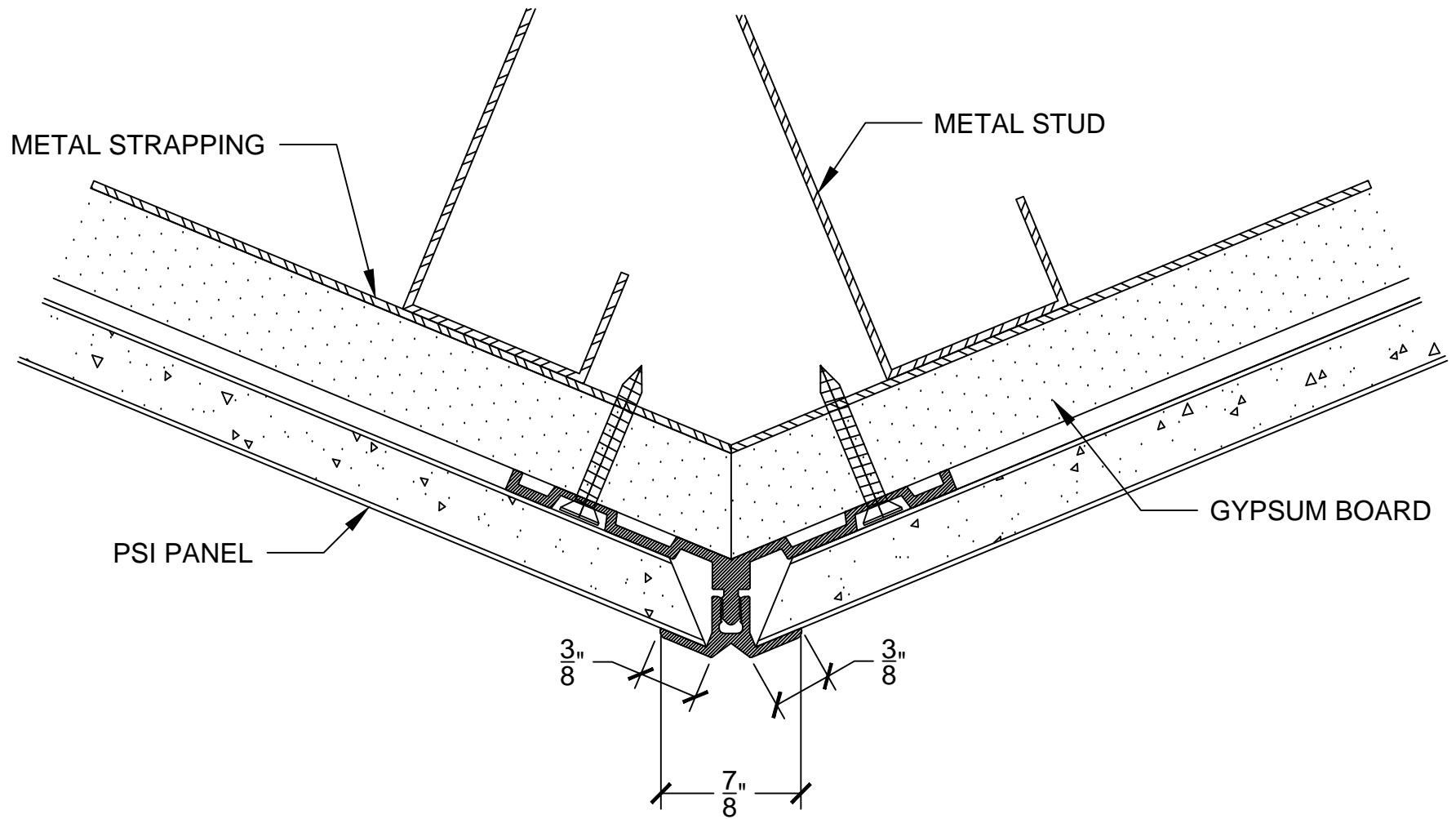

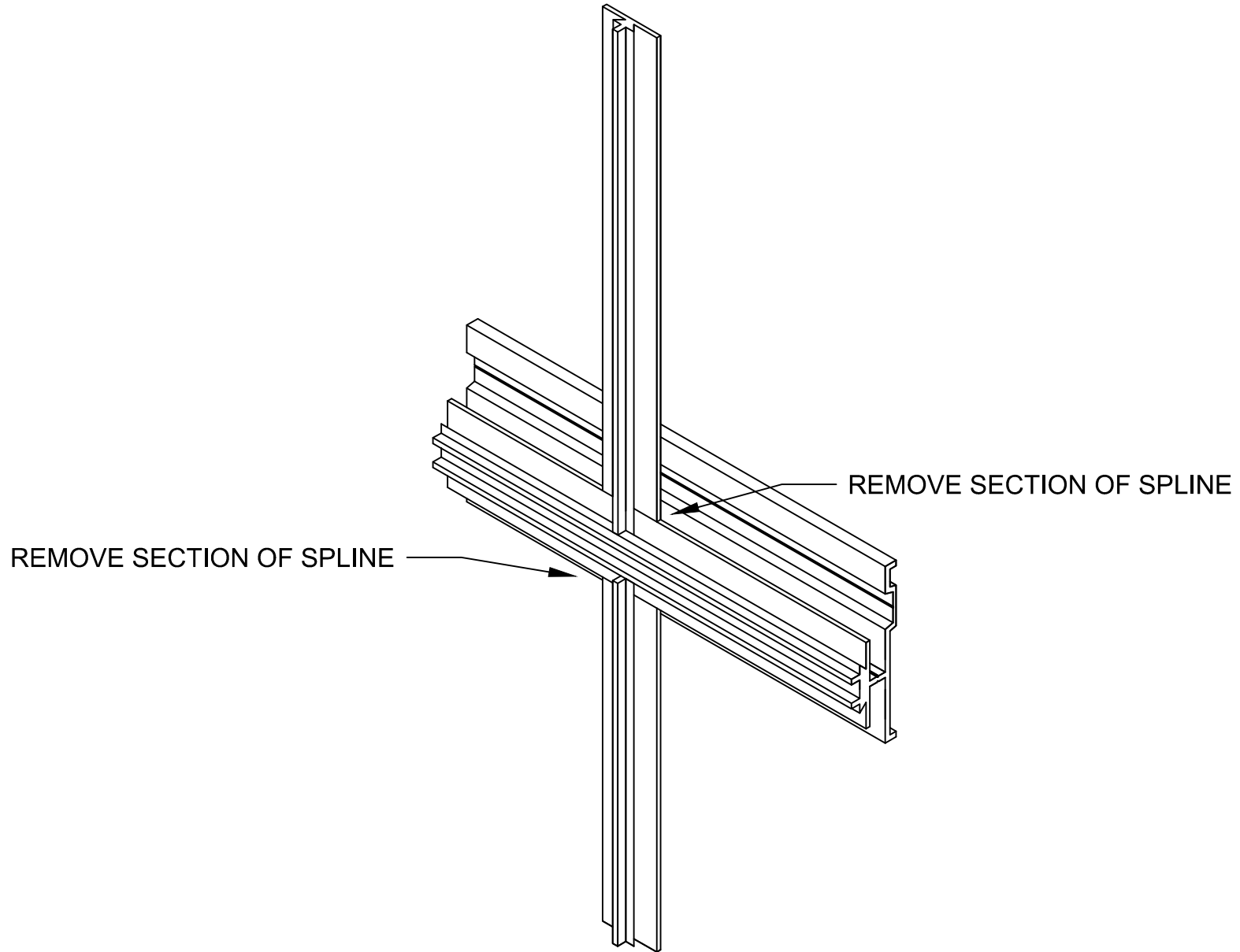

PANEL SPECIALISTS INC.
WALL PANEL SYSTEM 632-631

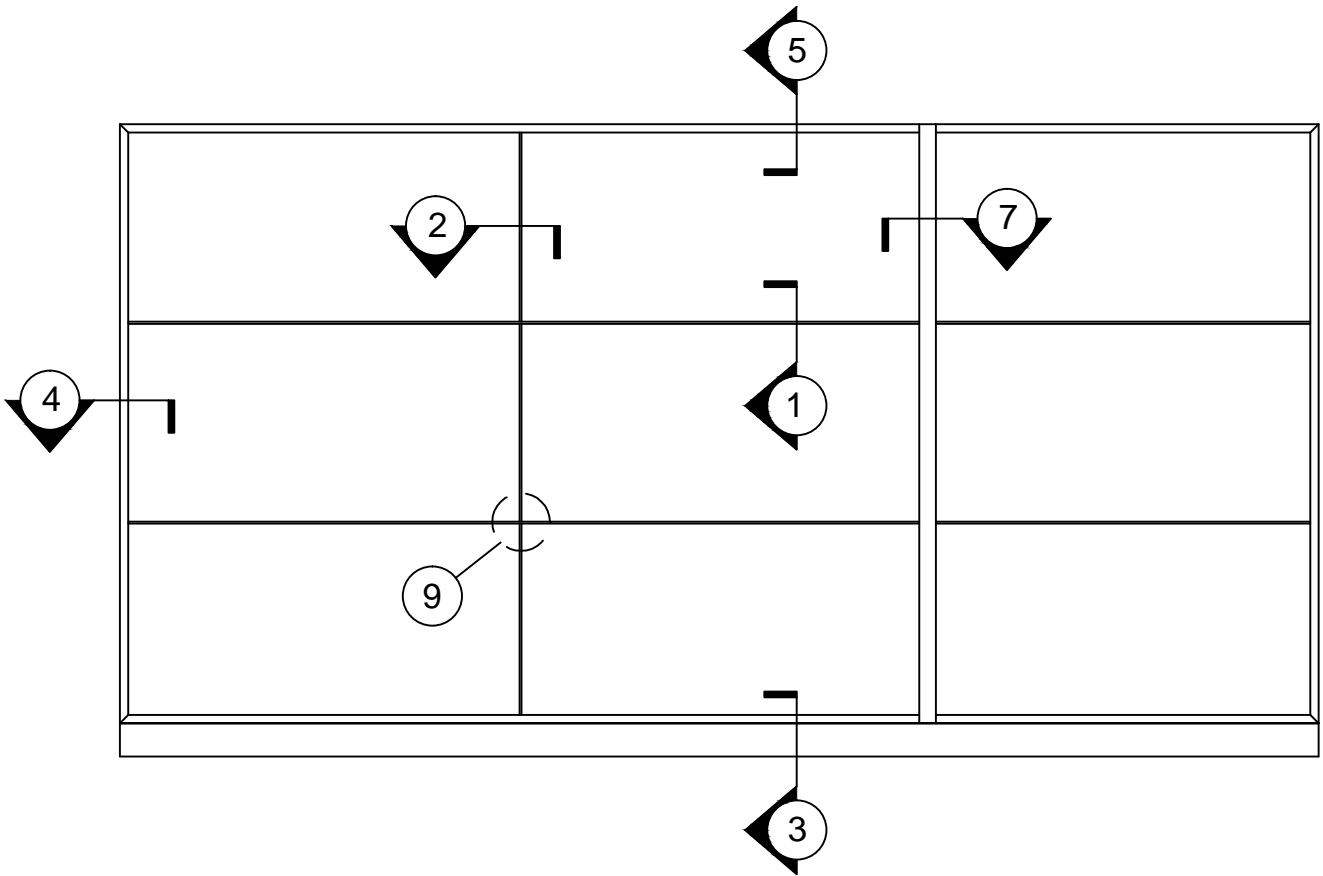

ELEVATION VIEW

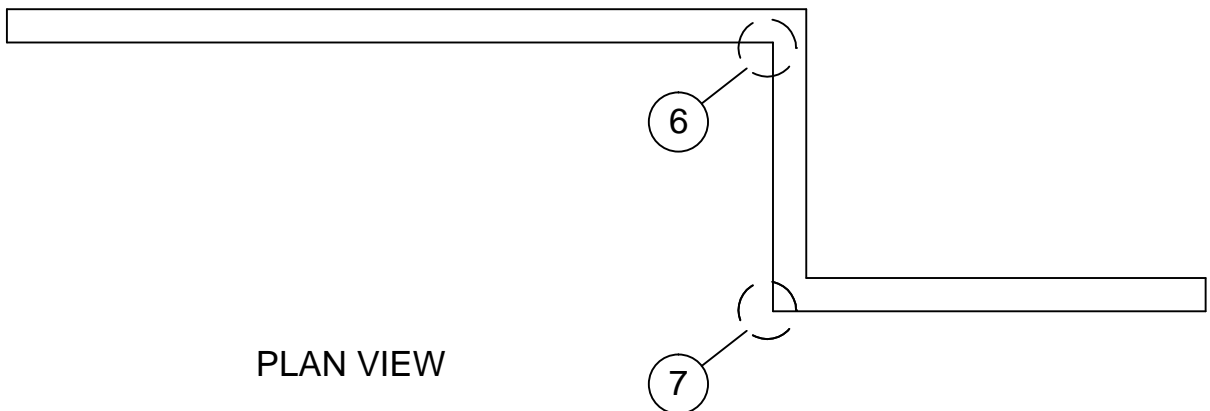

PLAN VIEW